



HANDYWAY CO.,LTD

Taiwan

📍 NO. 101-16, Sec. 1, Zhong Xing Rd., Hemei Town, Changhua 50854 Taiwan.

☎ 886-4-7355866

☎ 886-4-7355865

✉ sales@handyway.com.tw

🌐 www.handyway.com.tw

China

📍 No. 90 Quzhong Road, Ludu Town, Taicang City,
Jiangsu China 215412

☎ 86-512-82785667

☎ 86-512-82785679



Website



THE PROFESSIONAL MAKER OF THE HIGH SECURITY LOCK PRODUCTS





**BELIEVE IN HANDYWAY.
BELIEVE IN THE FUTURE.**

ABOUT HANDYWAY CO., LTD.

Established in 1990, HANDYWAY Company is committed to provide high quality locks manufacturing operation. According to the professional security system, appearance, durability and superior quality of our products, they are sold in more than 25 countries.

BEYOND THE LOCK, BEYOND THE FUTURE

Our core strategy is to determine innovation and stronger security system at ODM/OEM. We believe in supporting our customers to gain rich harvest, to a win-win result, now and in the future days.

ABOUT COMPANY

MACHINE INTRODUCTION



Zinc casting machine



CNC lathe



Circle cutting



Automatic injection machine



The key opens the tooth thunder to carve to hit the number and the key ring integration machine



All in one machine of key teeth opening ring and key ring

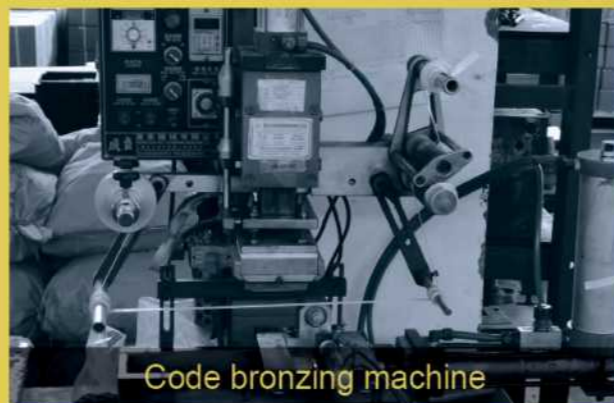

Code bronzing machine



Key milling machine



Laser engraving machine



CNC rounding machine

NEW PRODUCT OF THE YEAR



CL-619



CL-879



CL-101N



CHL-881P



CHL-879



CHL-879P



CL-874



AC-101N



ZL-002



CHL-881S



CHL-881S



CHL-101N



WL-106



CHL-874



CHL-881



FL-806-E lock



FL-301 W/CHAIN



FL-301 W/CABLE

HANDYWAY

INDEX

- 01 CABLE LOCK
- 02 COMBINATION LOCK
- 03 U-LOCK
- 04 POCKET LOCK
- 05 RETRACTABLE LOCK
- 06 FRAME LOCK
- 07 MULTI-PURPOSE
- 08 PAD LOCK
- 09 HEAVY DUTY CHAIN/ JOINT LOCK
- 10 LOCK BRACKETS
- 11 CYLINDER
- 12 PRODUCT PACKAGE

HANDWAY



CABLE LOCK <<

CL-619

Dia. 12mm (A) x Length 60cm (B)

- 1. Silicone Overmolded
- 2. Different colors available

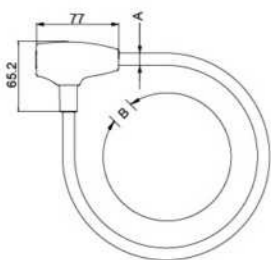

CL-879

Dia. 10/12mm (A) x Length 60/90/120/150/180cm (B)

- 1. Integrated Cable Lock
- 2. Reliable steel cable locks provide expedient protection
- 3. Vinyl coating protects bike

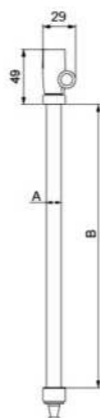

CL-101N W/BL-722

Dia. 15mm (A) x Length 60/90/120/150/180cm (B)

- 1. Heavy duty self coiling cable
- 2. Vinyl coating prevents scratches professional lock
- 3. Sliding cover protects the keyway from dust

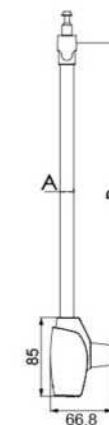

CLM-608

Dia. 12mm (A) x Length 60/90/120/150/180cm (B)

- 1. Shape memory lock
- 2. Flexible TPE coating on the locking mechanism
- 3. Flexible TPE cable cover with different colors available

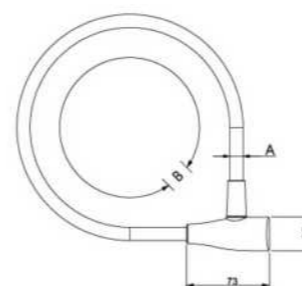

CLM-613

Dia. 12mm (A) x Length 60/90/120/150/180cm (B)

- 1. Shape memory lock
- 2. Flexible TPE coating on the locking mechanism
- 3. Flexible TPE cable cover with different colors available

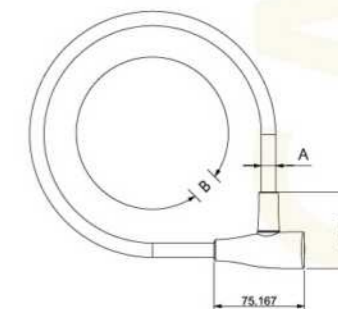

01 CABLE LOCK <<

CL-613



Dia. 10/12mm (A) x Length 60/90/120/150/180cm (B)

1. Flexible TPE coating on the locking mechanism
2. Flexible TPE cable cover with different colors available

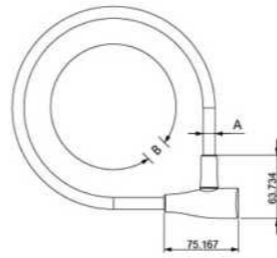

W/BL-758 BRACKET

CL-419

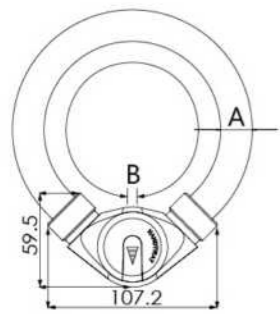

Dia. 15/18/20mm (A) x Length 60/90/120/150/180cm (B)

1. V-shaped Integrated Cable Lock
2. Lock pin spring out upon opening



CL-608



Dia. 10/12mm (A) x Length 60/90/120/150/180cm (B)

1. Flexible TPE coating on the locking mechanism
2. Flexible TPE cable cover with different colors available

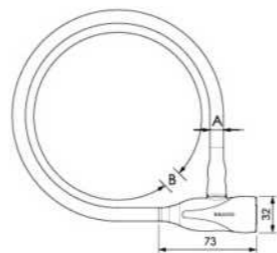

CL-313C W/BL-313 BRACKET



Dia. 8/10/12mm (A) x Length 60/90/120/150/180cm (B)

1. Reliable steel cable locks provide expedient protection
2. Vinyl coating protects bike
3. Two keys are supplied with the lock

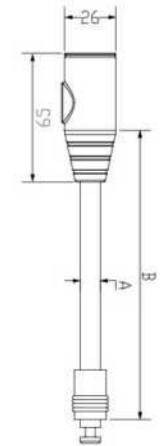

CL-445

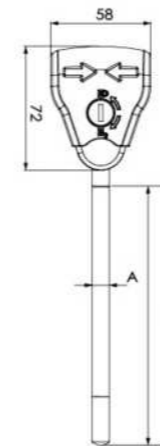

Dia. 10mm (A) x Length 120/150/180/210cm (B)

1. Adjustable cable lock
2. Soft rubber cover



CL-407 W/BL-407 or W/BL-758 BRACKET



Dia. 8/10/12mm (A) x Length 60/90/120/150/180cm (B)

1. Sliding Dust cover protects keyway from natural elements
2. Carry bracket including
3. Reliable steel cable locks provide expedient protection
4. Vinyl coating protects bike
5. Professional key Lock



BL-407

BL-758

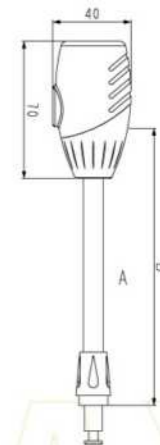

01 CABLE LOCK <<

CL-200 W/BL-718 BRACKET 2



Dia. 8/10/12mm (A) x Length 60/90/120/150/180/cm (B)

1. High Security Cable Lock
2. Lock pin spring out upon opening
3. Variety color assortment is available
4. Vinyl coating and scratch guard
5. Patented bracket is extremely convenient

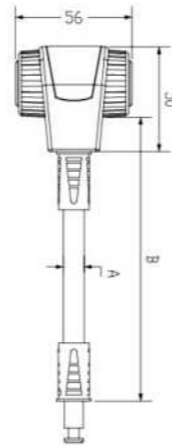

CL-925 W/BL-714 BRACKET 2



Dia. 8mm (A) x Length 60/90/120/150/180/cm (B)

1. Integrated Cable Lock
2. Reliable steel cable locks provide expedient protection
3. Vinyl coating protects bike
4. Carrying bracket including

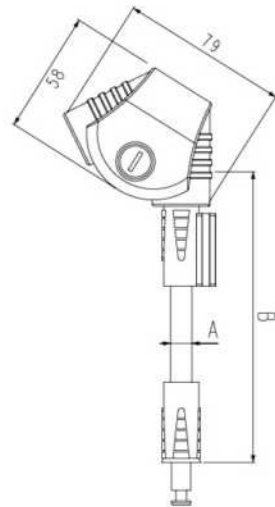
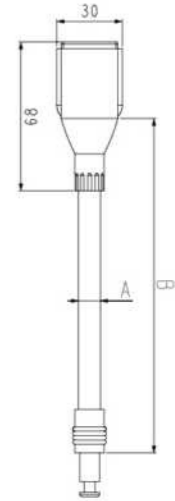

W/BL-718 BRACKET CL-220 2

Dia. 10/12/15mm (A) x Length 60/90/120/150/180/cm (B)

1. V-shaped Integrated Cable Lock
2. Lock pin spring out upon opening
3. Vinyl coating and scratch guard
4. Patented bracket is extremely convenient



W/BL-758 BRACKET CL-428 2



Dia. 10/12mm (A) x Length 60/90/120/150/180/cm (B)

1. Integrated Cable Lock
2. Reliable steel cable locks provide expedient protection
3. Vinyl coating protects bike



CL-810 W/BL-719 BRACKET 2



Dia. 8/10/12mm (A) x Length 60/90/120/150/180/cm (B)

1. Integrated Cable Lock
2. Reliable steel cable locks provide expedient protection
3. Vinyl coating protects bike
4. Carrying bracket including

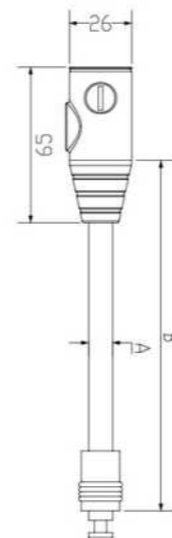

CL-429 3



Dia. 15mm (A) x Length 60/90/120/150/180/cm (B)

1. Integrated Cable Lock
2. Reliable steel cable locks provide expedient protection
3. Vinyl coating protects bike

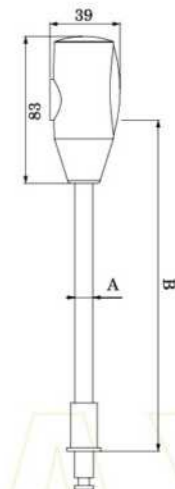

01 CABLE LOCK <<

CL-8100 W/BL-718 BRACKET



Dia. 8/10/12mm (A) x Length 60/90/120/150/180/cm (B)

1. Integrated Cable Lock
2. Carrying bracket including
3. Patent design
4. Reliable steel cable locks provide expedient protection
5. Vinyl coating protects bike

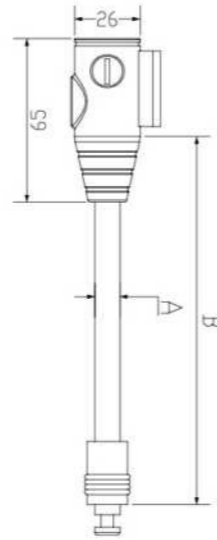

COMBINATION LOCK <<

SW-610



Dia. 8/10/12/15mm (A) x Length 120/150/180/cm (B)

1. Heavy duty security
2. Ideal for securing Bicycle, Motorcycle
3. Straight Cable



CL-874

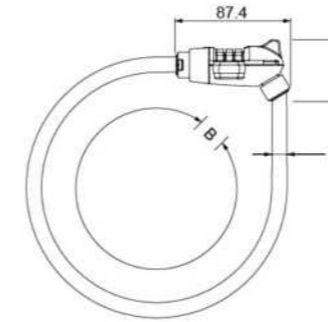

Dia. 12mm (A) x Length 60cm (B)

1. Adorable shape with different colors available
2. Resettable combination lock



SW-611



Dia. 8/10/12/15mm (A) x Length 120/150/180/cm (B)

1. Heavy duty security
2. Ideal for securing Bicycle, Motorcycle
3. Coiled Cable



CLM-866



Dia. 12mm (A) x Length 60/90/120/150/180/cm (B)

1. Shape memory lock
2. Flexible TPE coating on the locking mechanism
3. Flexible TPE cable cover with different colors available

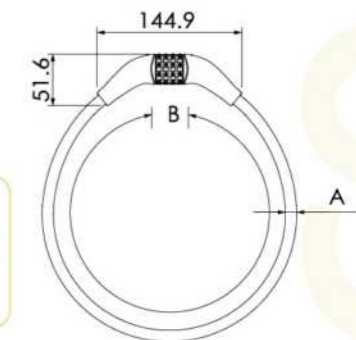

02 COMBINATION LOCK <<

CL-867



Dia. 5mm (A) x Length 90/120/150/180/cm (B)

1. Resettable code
2. Variety color assortment is available
3. Vinyl coating and scratch guard

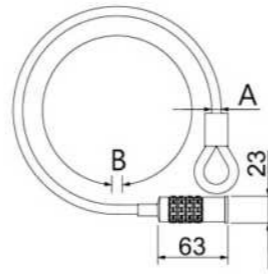

CL-8612 W/BL-722 BRACKET



Dia. 8/10/12mm (A) x Length 60/90/120/150/180/cm (B)

1. Integrated combination lock
2. Resettable code
3. Tough vinyl cable cover

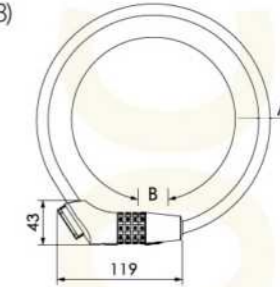

W/BL-724 BRACKET CL-866

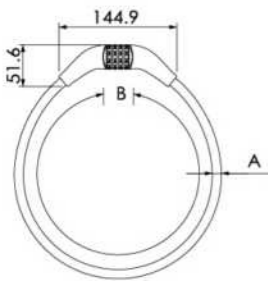

Dia. 10/12mm (A) x Length 60/90/120/150/180/cm (B)

1. Flexible material coatings on the locking mechanism
2. Resettable code
3. Flexible TPE cable cover with different colors available



W/BL-722 BRACKET CL-8613

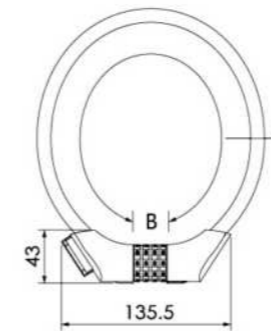

Dia. 8/10/12mm (A) x Length 60/90/120/150/180/cm (B)

1. Integrated combination lock
2. Resettable code
3. Tough vinyl cable cover



CL-861 W/BL-724 BRACKET



Dia. 8/10/12mm (A) x Length 60/90/120/150/180/cm (B)

1. Integrated combination lock
2. Resettable code
3. Tough vinyl cable cover

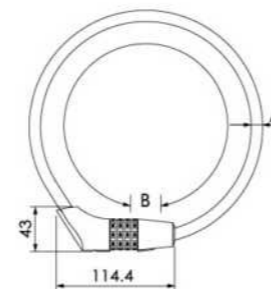

CL-8614 W/BL-724 BRACKET



Dia. 8/10/12mm (A) x Length 60/90/120/150/180/cm (B)

1. Integrated combination lock
2. Resettable code
3. Tough vinyl cable cover

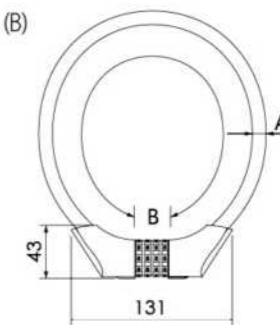

02 COMBINATION LOCK <<

CL-402 W/BL-402 or W/BL-724 BRACKET



Dia. 10/12mm (A) x Length 60/90/120/150/180/cm (B)

1. Integrated combination lock
2. Carry Bracket Including
3. User Settable Combination
4. Vinyl Coating Protects Bikes

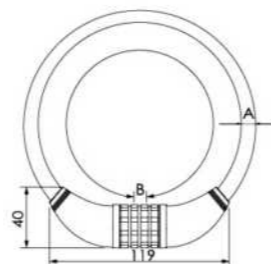

BL-402



BL-724

W/BL-724 BRACKET CL-870

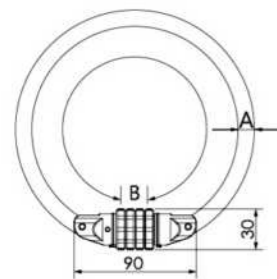

Dia. 8/10/12mm (A) x Length 60/90/120/150/180/cm (B)

1. Integrated combination lock
2. Resettable code
3. Carry Bracket Including



U-LOCK <<

W/BL-722 or W/BL-768 BRACKET UL-816N

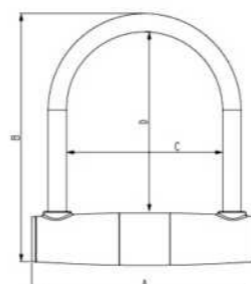

Outside 170mm (A) x 253mm (B), Inside 116mm (C) x 205mm (D), Weight 1100g
 Outside 170mm (A) x 278mm (B), Inside 116mm (C) x 230mm (D), Weight 1150g
 Outside 170mm (A) x 328mm (B), Inside 116mm (C) x 280mm (D), Weight 1260g

1. Finland keys, steel U shackle
2. Lock body: black & orange
3. Shackle diameter with PVC: 14mm
4. Pulling test: 2000kg



BL-722

BL-768



UL-1020

Outside 108mm (A) x 117mm (B), Inside 55mm (C) x 60mm (D), Weight 500g
 Outside 108mm (A) x 250mm (B), Inside 55mm (C) x 200mm (D), Weight 767g

1. Mini U lock
2. Finland keys, steel U shackle
3. Lock body: black & orange
4. Shackle diameter with PVC: 14mm
5. Pulling test: 2000kg

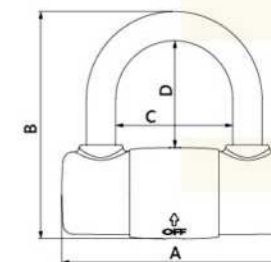

HANDWAY

03 U-LOCK

UL-802 W/BL-718 or W/BL-722 BRACKET



Outside 180mm (A) x 245mm (B), Inside 108mm (C) x 200mm (D), Weight 832g
 Outside 180mm (A) x 320mm (B), Inside 108mm (C) x 270mm (D), Weight 980g

1. High security disc-style cylinder
2. Sliding dust cover protects cylinder
3. Shackle diameter with PVC: 14mm
4. Pulling test: 500kg

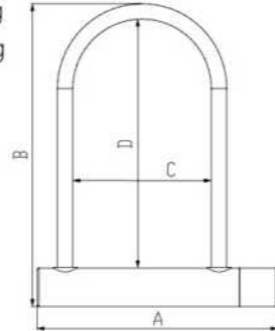

UL-807 W/BL-722 or W/BL-768 BRACKET



Outside 170mm (A) x 260mm (B), Inside 106mm (C) x 200mm (D), Weight 1190g
 Outside 170mm (A) x 335mm (B), Inside 106mm (C) x 278mm (D), Weight 1390g

1. Shackle Hardened steel
2. 7 pin round-key cylinder
3. Carrying bracket including
4. Shackle diameter with PVC: 16mm
5. Pulling test: 1200kg

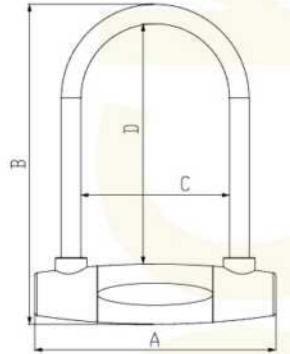

UL-801

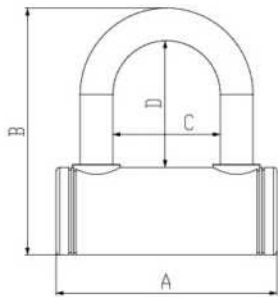

Outside 95mm (A) x 90mm (B),
 Inside 43mm (C) x 40mm (D), Weight 500g

1. Mini U lock
2. Shackle Hardened steel
3. 7 pin round-key cylinder
4. Shackle diameter with PVC: 16mm
5. Pulling test: 1200kg



UL-805



Outside 80mm (A) x 80mm (B), Inside 45mm (C) x 48mm (D), Weight 237g
 Outside 80mm (A) x 170mm (B), Inside 45mm (C) x 142mm (D), Weight 357g

1. Mini U combination Lock
2. Shackle Hardened steel
3. Shackle diameter with PVC: 12mm
4. Pulling test: 200kg

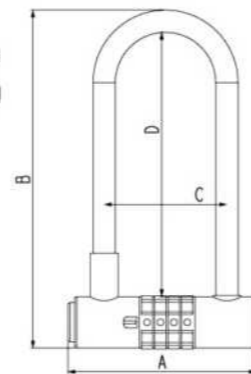

STL-2500C



Dia. 2.4mm (A) x Length 120/150/180cm (B)

1. Quick and easy to use security
2. Resettable combination lock

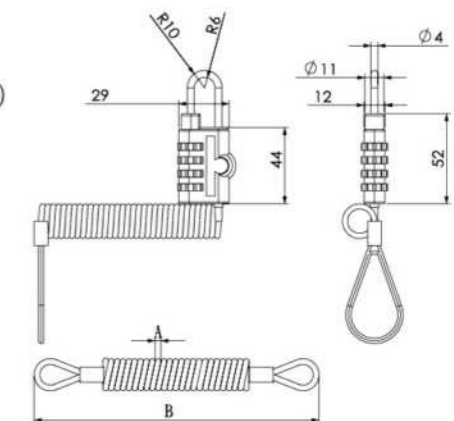

POCKET LOCK

04 POCKET LOCK <<

STL-2900C



Dia. 2.4mm (A) x Length 120/150/180cm (B)

1. Quick and easy to use security
2. Resettable combination with key lock

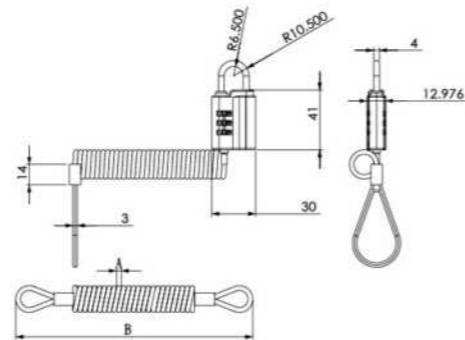

SKL-3000C

Dia. 2.4mm (A) x Length 120/150/180cm (B)

1. Quick and easy to use security
2. Resettable combination lock

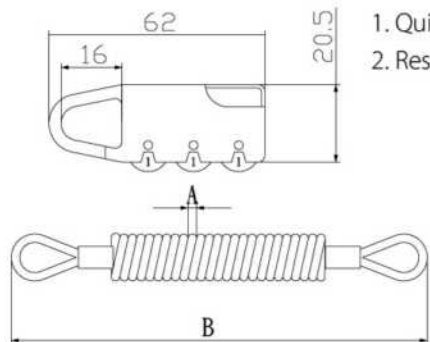

SKL-6000C

Dia. 2.4mm (A) x Length 120/150/180cm (B)

1. Quick and easy to use security
2. Resettable combination lock

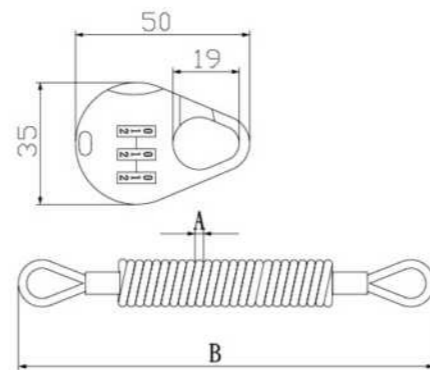

STL-2800C

1. Pocket size for easy carrying
2. Extra flexible steel cable
3. Diameter: 1.5mm, Length: 120cm

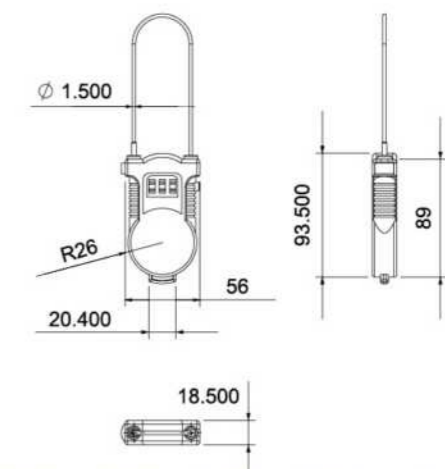

RETRACTABLE LOCK <<

HANDWAY



FRAME LOCK <<

FL-806

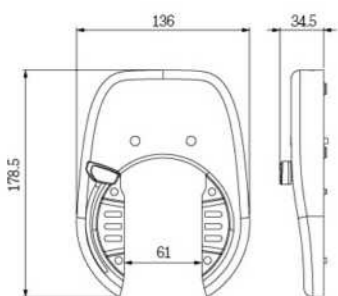

1. Electronic lock, customized locking and unlocking method
2. Specially hardened shackle
3. Extra-strengthened, Impact-resistant, Hardened steel casing
4. Weight: 468g



FL-600



1. Specially hardened shackle
2. Extra-strengthened, Impact-resistant, Hardened steel casing
3. Weight: 555g

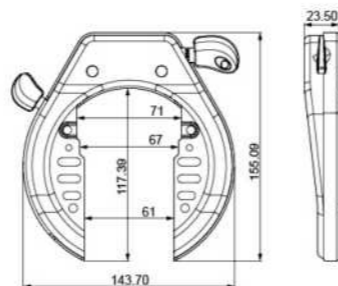

FL-605



1. Material: Aluminum alloy
2. Aluminum alloy frame lock with hardened steel shackle

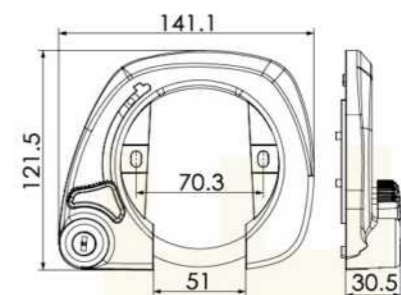

FL-301

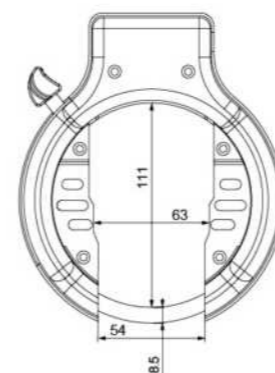

1. Specially hardened shackle
2. Extra-strengthened, Impact-resistant, Hardened steel casing
3. Weight: 424g



FL-301 W/CABLE & BL-002



1. Specially hardened shackle
2. Extra-strengthened, Impact-resistant, Hardened steel casing
3. Quick links, hooks and cable loops are available

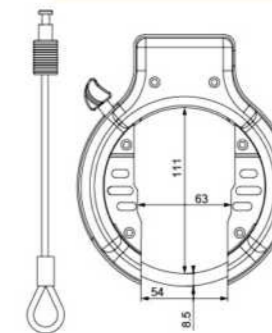

06 FRAME LOCK

FL-301 W/CHAIN



1. Specially hardened shackle
2. Extra-strengthened, Impact-resistant, Hardened steel casing
3. Quick links, hooks and cable loops are available
4. Heavy duty security

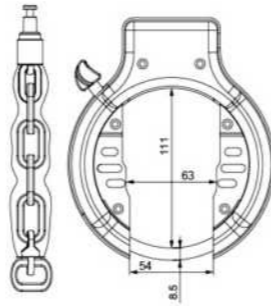

FL-502

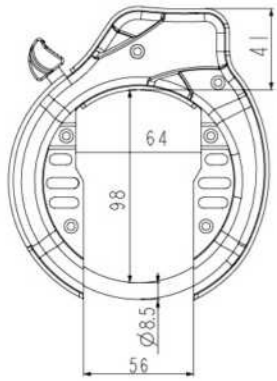

1. Specially hardened shackle
2. Extra-strengthened, Impact-resistant, Hardened steel casing
3. Weight: 576g



ZL-002



Length 60cm

1. Adjustable locking position
2. 3 Digit resettable combination lock
3. Lightweight, convenient to carry
4. Multiple uses, such as protecting the bike and securing luggage and accessories
5. Weight: 133g

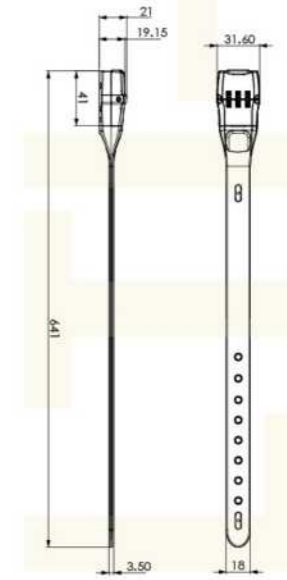

WL-106

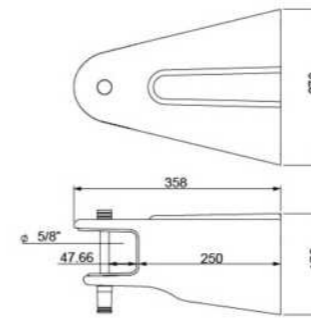

1. Security Bicycle Storage Hanger
2. Internal structure of specially hardened steel
3. Extra-strengthened, Impact-resistant casing
4. Used with 5/8" hitch pin lock
5. Weight capacity: 40kg



UL-1020 W/SW-610



Dia. 8/10/12/15mm (A) x Length 120/150/180/cm (B)

1. Heavy duty security
2. Ideal for securing Bicycle and Motorcycle

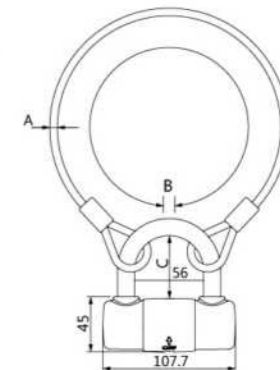

MULTI-PURPOSE

HANDWAY

07 MULTI-PURPOSE <<

CP-005



- Chain size: 10mm x 10mm x 100cm (A)
1. Heavy duty security
 2. Ideal for securing Bicycle and Motorcycle
 3. Weight of mini u lock: 500g, pulling test: 1200kg

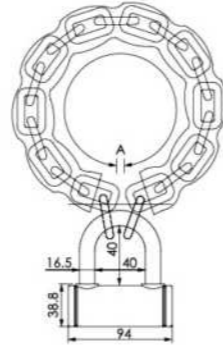

UL-801 W/SW-610



- Dia. 8/10/12/15mm (A) x Length 120/150/180/cm (B)
1. Heavy duty security
 2. Ideal for securing Bicycle and Motorcycle

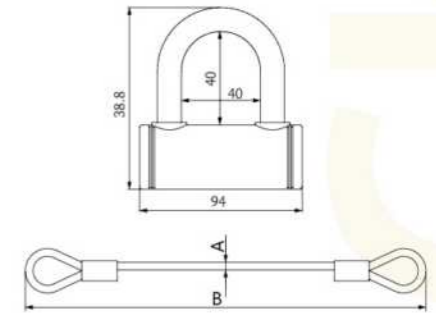

CP-006

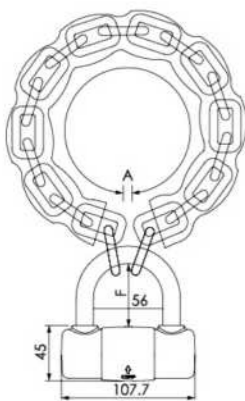

- Chain size: 8mm x 8mm x 100cm or 10mm x 10mm x 100cm (A)
1. Heavy duty security
 2. Ideal for securing Bicycle and Motorcycle
 3. Weight of mini u lock: 500g, pulling test: 2000kg



CL-413



- Dia.: 25.4~31.8mm (A)
Cable size: 10mm (B) x 120cm (C)
1. Material: Zinc alloy, Lock body ED black finish, lock top chrome plated
 2. With 2 keys and 1pc velcro

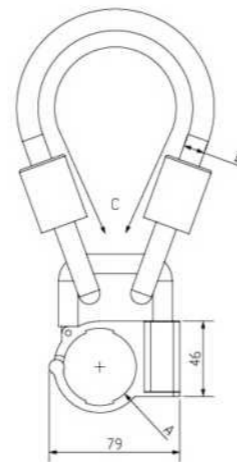

PD-04



- 40mm, 50mm
1. Armored hardened steel case
 2. Hardened steel shackle

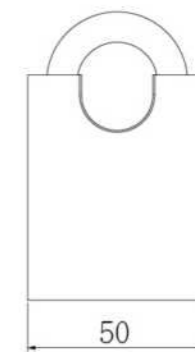

PAD LOCK <<

HANDWAY

08 PAD LOCK <<

PD-05



- 40mm, 50mm, 70mm
1. Round disk Padlock
 2. 70mm armor protected shackle

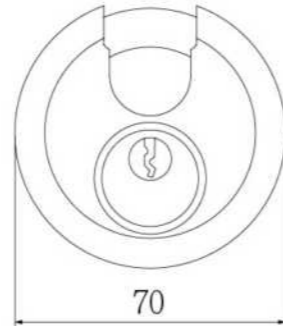

PD-07

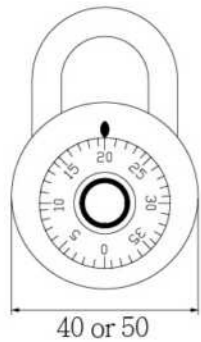

- 40mm, 50mm
1. Preset combination Padlock
 2. Hardened steel shackle



PD-08



- 40mm, 50mm
1. Laminated steel padlock with plated steel body
 2. Hardened steel shackle

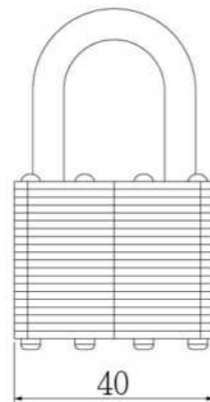

HEAVY DUTY CHAIN/ JOINT LOCK <<

CHL-874

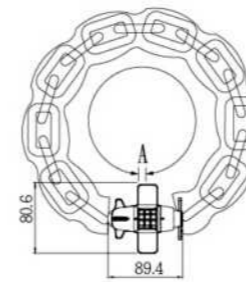

- Chain size: 4mm x 4mm x 60cm (A)
1. Adorable shape with different colors available
 2. Resettable combination lock
 3. Chain with PP sleeve to prevent damage of bicycle's paintwork



CHL-879



- Chain size: 4mm x 4mm x 60cm (A)
1. 4mm strong square chain
 2. CHL-879 PP sleeve
CHL-879P PET sleeve



CHL-879P

CHL-879P

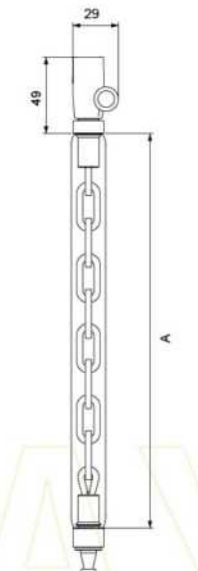

HANDWAY

09 HEAVY DUTY CHAIN/ JOINT LOCK

CHL-881



Chain size: 4mm x 4mm x 60cm (A)

1. 4mm strong square chain
2. Resettable combination lock
3. CHL-881 PP sleeve
CHL-881P PET sleeve



CHL-881P

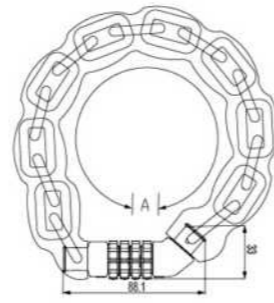

AC-101N



Chain size: 18mm (A) x 60/90/120cm (B)

1. Steel sleeve resists cutting and sawing
2. Vinyl coating prevents scratches professional lock
3. Sliding cover protects keyway from dust

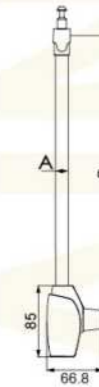

CHL-881S

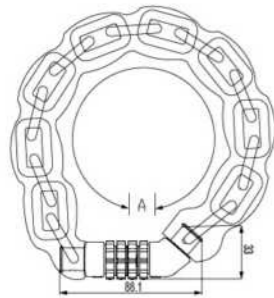

Chain size: 4mm x 4mm x 60cm (A)

1. Resettable combination lock
2. Adorable code patterns and attractive silicone printing
3. 4mm chain with PP sleeve to prevent damage of bicycle's paintwork



CHL-419

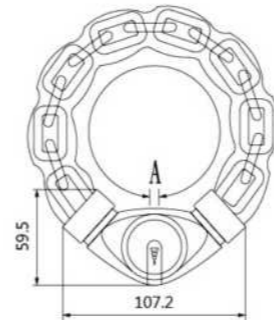

Chain size: 6mm x 6mm x 100cm or 8mm x 8mm x 100cm or 10mm x 10mm x 100cm (A)

1. Nylon cover won't chip your paint
2. V-shaped lock head



CHL-101N



Chain size: 5mm x 5mm x 60/90/120cm (A)

1. Chain with PP sleeve to prevent damage of bicycle's paintwork
2. Sliding cover protects keyway from dust

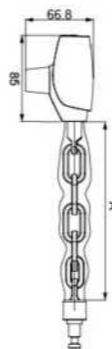

CHL-428



Chain size: 6mm x 6mm x 90cm or 6mm x 6mm x 100cm (A)

1. 6mm chain with PP sleeve to prevent damage of bicycle's paintwork
2. Two keys are supplied with the lock

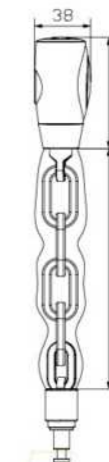

09 HEAVY DUTY CHAIN/ JOINT LOCK <<

CHL-870



Chain size: 6mm x 6mm x 100cm or 8mm x 8mm x 100cm (A)
 1. Chain with PP sleeve to prevent damage of bicycle's paintwork
 2. Resettable code

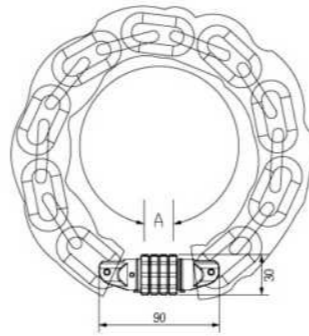

CP-001

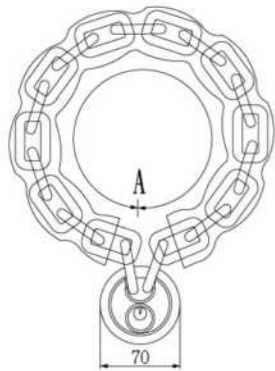

Chain size: 6mm x 6mm x 100cm or 8mm x 8mm x 100cm or 10mm x 10mm x 100cm (A)
 1. Chain with Padlocks
 2. PP cover won't chip your paint



HL-220



Chain size: 6mm x 6mm x 100cm or 8mm x 8mm x 100cm or 10mm x 10mm x 100cm (A)
 1. PP cover won't chip your paint
 2. V-shaped lock head

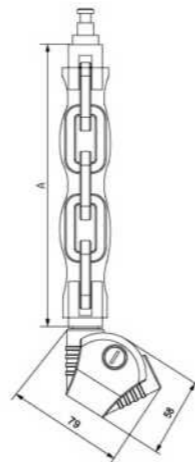

10 LOCK BRACKETS <<



BL-002



BL-313



BL-402



BL-407



BL-714



BL-718



BL-719



BL-722



BL-724



BL-758



BL-768

HANDYWAY

11 CYLINDER <<



KF-01



KF-02



KF-03



KF-04



KF-06



KF-07



KF-608



KF-08



KF-09



KF-10



KF-11



KF-12



KR-01



KL-01



KBL-01



KBL-02



KBL-03



KBL-04



KBL-05

12 PRODUCT PACKAGE <<



Hanger card

Tied card

Color sleeve

U lock sleeve

Round card

Header card

Small label

PRODUCT PACKAGE

HANDYWAY